

Deze tekening is eigendom van NV RENSON, en mag niet gecopieerd, noch getoond worden aan derden zonder schriftelijke toestemming.

Zijaanzicht
Vue de dessus
Side view
Seitenansicht
Vista lateral

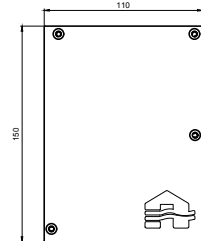

Doorsnede:
onderlat past volledig in de kast
Section:
bottom rail disappears into the box completely
Section:
Endschiene passt in die Kasette vollständig
Section:
la barre de charge disparaît dans le caisson complètement
Section:
Sección:

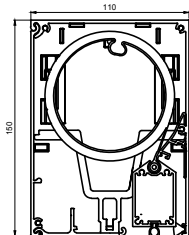

Bovenaanzicht
Vue de côté
Top view
Obenansicht
Vista desde arriba

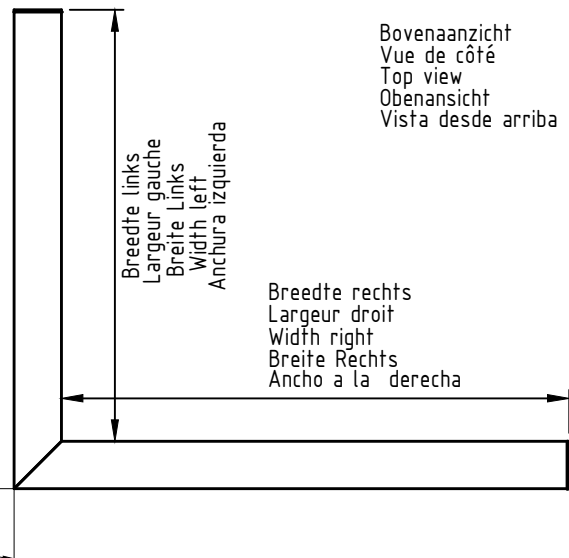

Breedte links
Largeur gauche
Breite Links
Width left
Anchura izquierda

Breedte rechts
Largeur droit
Breite Rechts
Ancho a la derecha

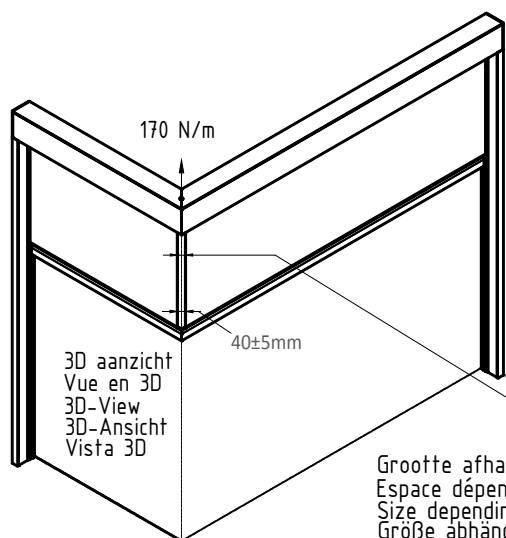

3D aanzicht
Vue en 3D
3D-View
3D-Ansicht
Vista 3D

Grootte afhankelijk van doektype en afmetingen
Espace dépendant du type de toile et de ses dimensions.
Size depending on fabric type and dimension
Größe abhängig vom Type des Tuches und Tuchabmessungen

Afgewerkte hoogte
Hauteur finie
Finished height
Fertige Höhe
Altura acabada

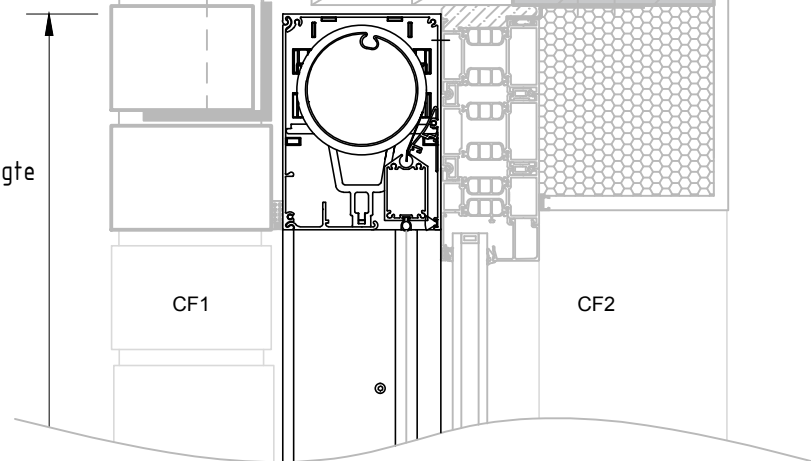

Afgewerkte hoogte
Hauteur finie
Finished height
Fertige Höhe
Altura acabada

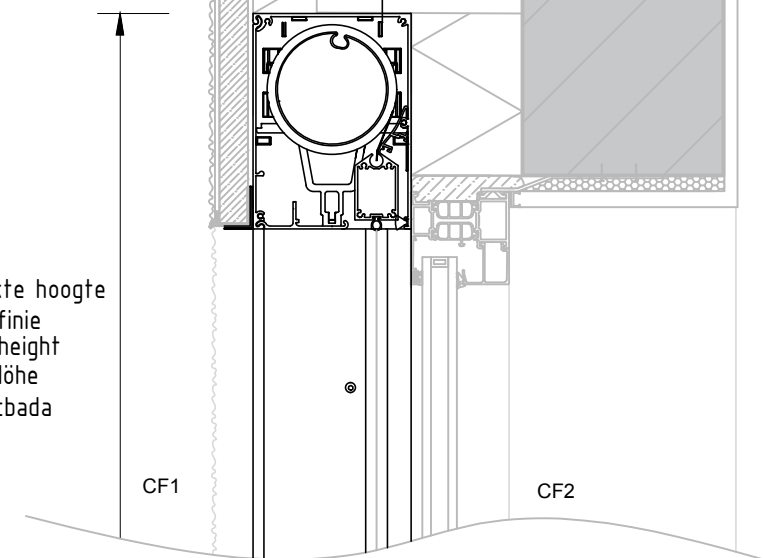

Escuadra de montaje
Montagebügel
sectional bracket
équerre locale
Lokale beugel

Indicatieve draagstructuur Niet meegeleverd
Structure portante pas inclus
Support structure not included
Tragstruktur nicht enthalten

Bovenaanzicht
Vue de côté
Top view
Obenansicht
Vista desde arriba

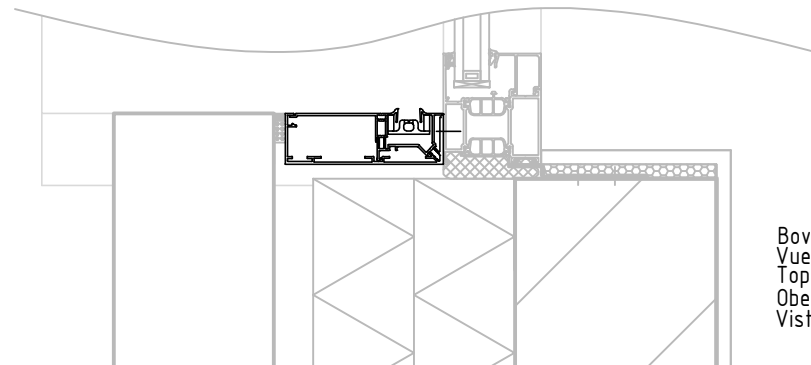

Montagesituatie 7
Montage 7
Installation method 7
Einbauweise 7
Tipo de montaje 7

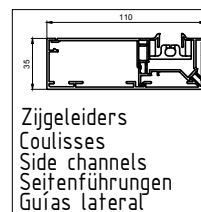

Zijgeleiders
Coulisses
Side channels
Seitenführungen
Guías lateral

Diepe zijgeleider 3 delen Standaard
Coulisse profonde 3 parties Standard
Deep side channel 3 parts Standard
Tiefe Seitenführung 3 Teile Standard
Profundidad guía lateral 3 partes Estandar



Zijgeleider 3 delen
Coulisse 3 parties
Side channel 3 parts
Seitenführung 3 Teile
Guía lateral 3 partes

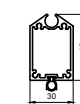

Onderlat
Barre de charge
Bottom rail
Die Endschiene
Perfil contrapeso

RENSON
Creating healthy spaces

Industriezone "Flanders field"
8790 Waregem (Belgium)
Tel. 056/62.71.11 Fax. 056/60.28.51



Getekend
msple

Datum
18/10/2017

Schaal
1:5

PANOVISTA

Versie
0

Formaat
A3

MS7/M7/IM7/EW7/17

Bladzijde
1/1

